



Engineered to be the fastest

QUICK START USER GUIDE



REVISED : 2020-12-18

**C-00165 DEMENTOR
1/8TH SCALE 4WD
ELECTRIC READY TO RUN**

www.corally.com

C-00165_manual

INTRODUCTION

Thank you for purchasing a Team Corally car. This manual describes the instructions for using the model and the electronic components. You will also find some tips on how to maintain your RC model so that you can enjoy it for years to come. You have purchased one of the most efficient models available on the market that has been designed by a team of professionals. You will also benefit from the best after-sales support. All Team Corally models guarantee a high quality of manufacture and performance that guarantees you a high satisfaction of use and services provided by the Team Corally. Always take the time to read the instructions carefully in order to follow all the procedures to use your RC model safely for you and for other people and property in the area. This will allow you to take full advantage of all the performance of your RC model.

Please also check the website www.corally.com/Downloads/ to check if you have the latest version of this instruction manual. (Version: see bottom cover of this manual)

If you have any questions about the model and its components, you can send a message to info@corally.com

We also recommend that you get help from an experienced model maker or your dealer.

You will find all the references of the spare parts on the website www.corally.com

TERM OF USE

The user is responsible for the use of your model. The user assumes all risks associated with the use of the model. This model is not intended for use by children under 14 years of age without the supervision of a responsible adult who is familiar with the dangers of using a RC model. Team Corally / JSP Group Intl bvba, its manufacturers, distributors and resellers cannot control the use and load of the model and therefore cannot be held responsible for any damage to property and damage caused to persons resulting from the use of this product. You must accept these conditions and consider yourself fully responsible for the use of this product. If not, do not use this product.

Due to the continuous development of our products, the exact specifications of the kit may vary. If you have a problem with your new kit, please contact the store where you purchased it, indicating the part number(s).

Team Corally / JSP Group Intl bvba reserves the right to change any specification without notice. All rights reserved.

READ FIRST

This owner's manual is designed for use with your vehicle and contains the instructions you will need to operate and maintain your vehicle.

- We know you want to start driving immediately after unpacking, but it is very important that you take the time to read this manual carefully, even if you are an experienced R/C driver.
- Read carefully and follow all instructions in this manual. Failure to comply with the instructions will be considered as abuse and/or negligence which may result in the cancellation of the warranty.
- Your vehicle is designed to operate on uneven terrain. However, dust, sand, water and carpet fibres can get into your car's workspaces and can damage your vehicle if they are not removed quickly. We do not guarantee any warranty on your vehicle against damage caused by external elements such as sand, dirt or water. Users are responsible for the maintenance and safe operation of this vehicle.
- This product is not a toy. It is not suitable for users under 14 years of age, unless they are supervised by adults.
- Never attempt to disassemble electronic components. These have been carefully calibrated at the factory.
- Only improve your car with parts made for your car. If you upgrade performance, replace the entire system (such as the motor, inverter, battery, etc.) so that all components are properly adapted. Any malfunction resulting from a custom modification will void your warranty.
- Before driving your vehicle, please read this manual in its entirety and examine your vehicle and radio control system for any defects.
- For better performance, some adjustments may be necessary.
- This vehicle requires a battery (included in the car or in the packaging). Make sure the vehicle's battery is sufficiently charged before driving, otherwise you may lose control of the vehicle.
- The radio transmitter requires 4 AA batteries (not included)
- Always remove or disconnect the battery from the vehicle to the inverter when not in use.
- Please drive your car in a spacious place. Never drive your car on the street or in traffic. Public places are subject to specific legislation by country, city, municipality, please comply with the legislation for the use of RC models in your region.
- This product is fully assembled in the factory. We accept no liability for damage and/or accidents resulting from custom modifications and/or malfunctions.

USE PRECAUTIONS

Failure to operate your model in a safe and responsible manner may result in injury to yourself, others or damage to property around you.

- Do not use your model on public roads or in areas where you may encounter pedestrians or riders.
- Do not operate in a congested area or in crowds.
- Do not operate in areas where loud noises can disturb others, such as hospitals and residential areas.
- Do not operate your model with obstructed line of sight, at night or near water.
- Your model is radio controlled, it is subject to possible radio interference. Radio interference can cause loss of control of your model. Be careful.
- Take care not to injure yourself while using tools to adjust or upgrade your model.
- Since the model contains small parts, keep out of reach of children while assembling and/or disassembling your model.
- If your model becomes stuck against an object, release the throttle and retrieve it by hand
- Do not continue to apply the throttle when your model is stuck. This may damage the motor and/or ESC/Receiver unit.
- Turn OFF your model and don't use it if it runs erratically. Please do not use your model again until the problem has been solved.
- Keep the wheels of the model off the ground when checking the operation of the radio equipment.
- When learning to operate your model, go to an area that has no obstacles that can damage your model.
- Before and after each use, check all the screws on the model.
- To maintain the best performance, check that all moving parts move freely.

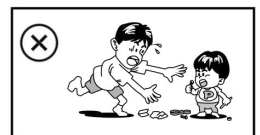
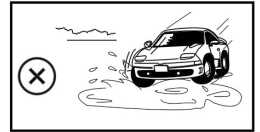
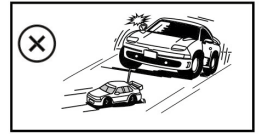

Take all necessary precautions before, during and after using your model. You are responsible for the safe assembly, maintenance and use of your model.

In case of any questions, contact your local reseller or contact Team Corally support for assistance.

SAFETY PRECAUTIONS

For your safety, always use wear gloves and goggles when assembling and maintaining your model.

Always take all necessary precautions when handling products (silicone oil, grease, thread lock, cyanolyte glue, fuel) for the operation of the model. (Refer to the manufacturer's instructions)

For your safety, to keep the warranty and obtain the best performance, always use original CORALLY genuine parts.

Contains: LEAD (CAS 7439-92-1) ANTIMONY (CAS 7440-36-0)

WARNING: This product contains a chemical known to the state of California to cause cancer and birth defects or other reproductive harm.

CAUTION: CANCER HAZARD

Contains lead, a listed carcinogen. Lead is harmful if ingested. Wash thoroughly after using.

DO NOT use product while eating, drinking or smoking.

If material defects or manufacturing faults should arise in a product distributed or manufactured by Team Corally / JSP Group Intl bvba, and purchased by a consumer, we Team Corally / JSP Group Intl bvba acknowledge the obligation to correct those faults or defects within the limitations described below. This manufacturer's warranty is in addition to, and does not affect, the legal or contractual rights of the consumer which arise from the purchase of such products. Team Corally / JSP Group Intl bvba guarantees the consumer that its products are free from material, manufacturing, and construction faults, as determined by the general state of knowledge and technology valid at the time of manufacturing. The fault responsible for causing the damage must be proven to have been present in the product at this time. Claims for compensation arising from consequential damage or product liability will not be considered valid unless they fall under peremptory provisions of the law. If material defects or manufacturing faults should arise in a product distributed or manufactured by Team Corally / JSP Group Intl bvba in the European community (EC) and purchased by a consumer, then Team Corally / JSP Group Intl bvba undertakes to correct those defects within the limitations described below. This manufacturer's declaration does not affect the consumer's legal or contractual rights regarding defects arising from the purchase contract between the consumer and the dealer or reseller. Extend of the Warranty

If a claim is made under warranty, we take at our discretion to repair or replace the defective goods. We will not consider supplementary claims, especially for reimbursement of costs relating to the defect (e.g. installation / removal costs) and compensation for consequent damages unless they are allowed by statute. This does not affect claims on legal regulations, especially according to the product liability law.

Provisions of the Warranty

The purchaser is required to make the warranty claim in writing, and must enclose original proof of purchase (e.g. invoice, receipt, delivery note) and the appropriate warranty card. He must send the defective goods to our local representatives or directly to Team Corally / JSP Group Intl bvba, Geelseweg 80, 2250 Olen, Belgium at his own risk and cost.

The purchaser should state the material defect or manufacturing fault, or symptoms of the fault, as accurate as possible, so that we can check if our warranty obligation is applicable. The goods are transported from the consumer to us, and from us to the consumer, entirely at the risk and cost of the consumer.

Invalidation of the Warranty

The consumer cannot make a claim under warranty when the fault is affecting the use of the product arising from natural wear, competition use, or improper use (including installation) or external forces. The consumer's adherence to the building and operating instructions relevant to the model, including the installation, operation, use of, and maintenance of, model-related components cannot be supervised by Team Corally / JSP Group Intl bvba. Therefore Team Corally / JSP Group Intl bvba is in no way liable for loss, damage, or costs resulting from improper use, or behaviour in any way connected to the above described provisions. Unless otherwise required by law, Team Corally / JSP Group Intl bvba is in no way whatever liable to provide compensation for damages arising from the improper use of the model (including personal injury, death, damage to buildings, loss of turnover, loss of business, or interruption of business, or any other direct, or indirectly caused, consequential damage).

Duration of Validity

The claim period is 24 months from the date of purchase of the product by the consumer from a dealer in the European Community (EC) counted from the date of purchase. The claim period is 12 months from the date of purchase of the product by the consumer from a dealer outside the European Community (EC) counted from the date of purchase. If a defect arises after the end of the claim period, or if evidence or documents required according to this declaration in order to make the claim valid are not presented until after this period, then the consumer forfeits any rights or claims from this declaration. The guarantee period is not prolonged by the granting of any claims within the framework of this warranty, especially in the case of repair or replacement. The guarantee period also does not restart in such cases.

Warranty Expiration

If we do not acknowledge the validity of a claim based on this declaration within the claim period, all claims based on this declaration will expire after six months from the time of registering the claim; however this cannot occur prior to the end of the claim period.

For any support, you can contact us by email at info@corally.com

LIPO BATTERY SAFETY PRECAUTIONS

- Follow and respect the manufacturer's instructions for use
- It is important to check that your ESC is set to LIPO if you are using a LIPO battery. Failure to comply with this instruction will result in increased battery discharge and may cause fire and damage to persons and property.
- When charging or storing LiPo batteries always use LiPo Safety Bag (Flame retardant).
- Always respect the maximum rate and voltage specified by the battery manufacturer.
- Charge the LIPO battery outdoors or in a ventilated area away from flammable objects and surfaces.
- NEVER leave your LiPo battery unattended while charging.
- If the battery swells during charging, stop charging immediately and disconnect the battery from the charger. Leave the battery outside for a few hours and observe. Then recycle the battery according to the instructions of your country/region. Never dispose of a LIPO battery with domestic waste.
- Before recycling your defective battery, it must be neutralized. Take a plastic container, fill it with water and add a lot of salt until the water becomes opaque. Place the LIPO battery in the water and leave for 24 hours. Check with a voltmeter that the voltage is 0.0V. Then recycle the battery according to local regulations.
- Never charge a damaged or inflated battery.
- Never discharge the battery cells below 3.2V.
- Always use the appropriate balancer/charger when charging your LiPo battery pack.
- When the battery is empty, check the temperature of the battery before charging it. If the battery is very hot, wait until it cools before charging it.
- Never charge a very hot battery as this may cause an explosion or fire.
- When the battery is empty, recharge it immediately. Do not store an empty battery, the battery will continue to discharge, it will fall below the minimum voltage and become unusable.

KIT CONTENT (Depends on the selected model)

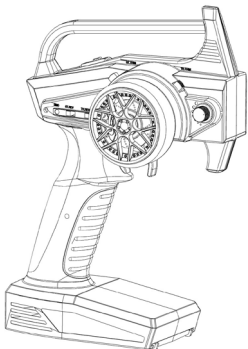

Transmitter

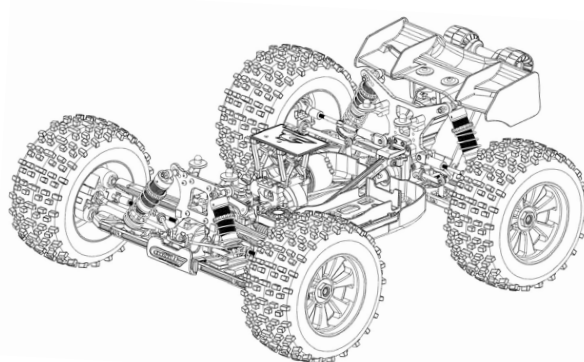

RTR Model (Chassis with Body)



www.corally.com/Downloads/

User Guide

REQUIRED FOR OPERATION (Not included)

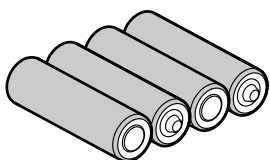

4x AA Batteries
for the Transmitter

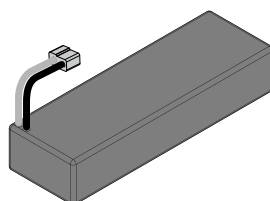

4S - 14.8V LiPo Battery

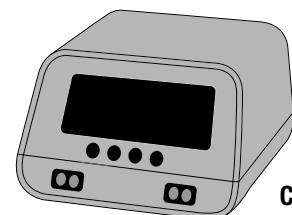

Charger

Hex Drivers

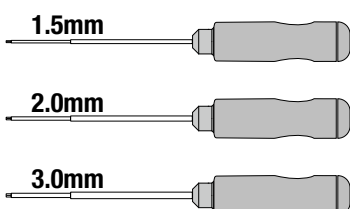

1.5mm

2.0mm

3.0mm

Cross Wrench

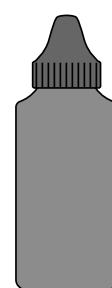
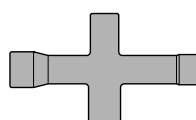

Silicone Oil
(for maintenance)

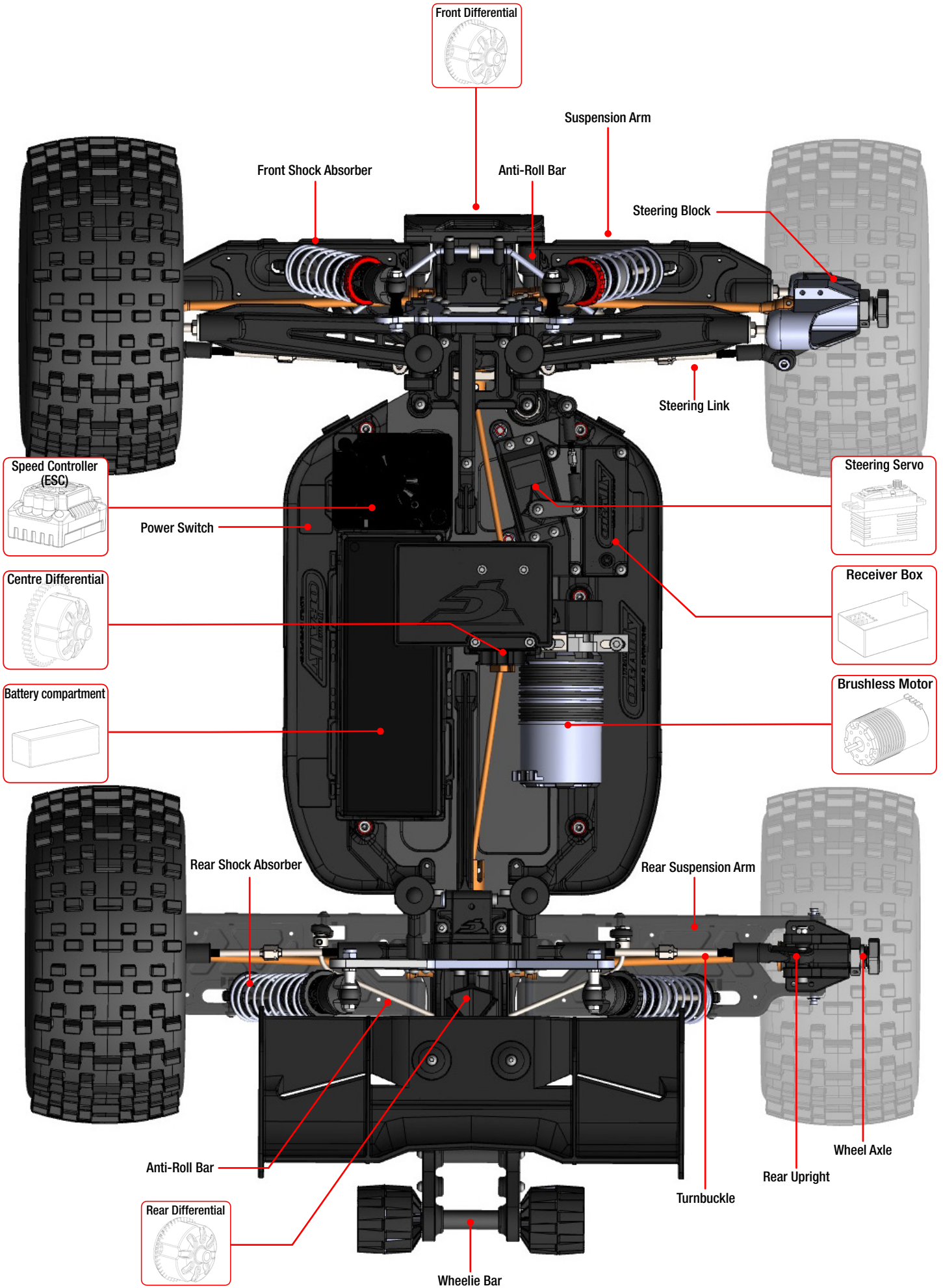

READ THE INSTRUCTIONS



CHARGE THE BATTERY

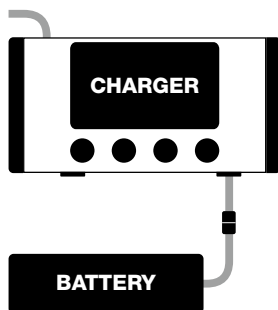

INSTALL 4x AA BATTERY

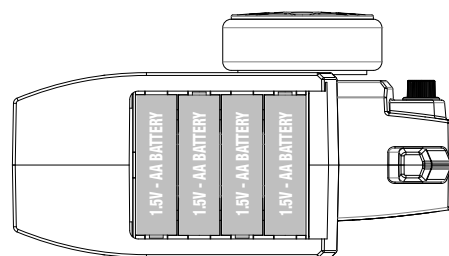

MAKE SURE THAT ALL SCREWS AND NUTS ARE TIGHTENED PROPERLY.

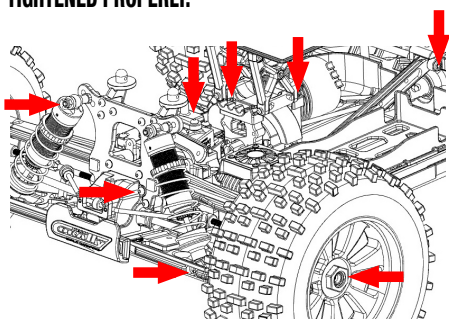

INSTALL THE BATTERY

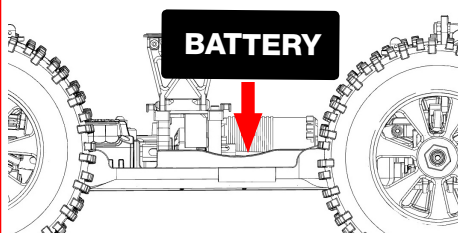

TURN ON THE TRANSMITTER (Always First)

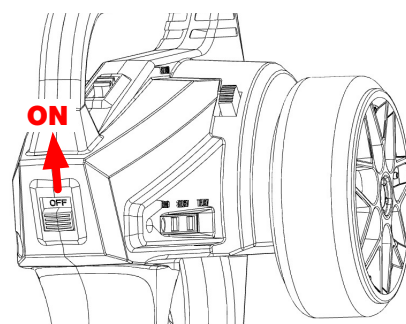

**1. CONNECT THE BATTERY TO THE ESC
2. SWITCH ON THE ESC**

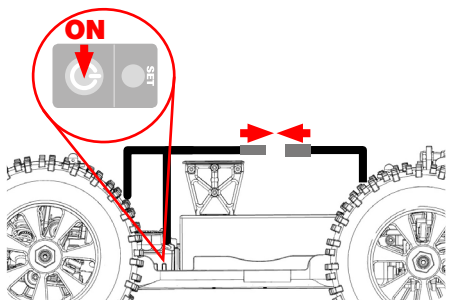

CHECK THE FUNCTIONS

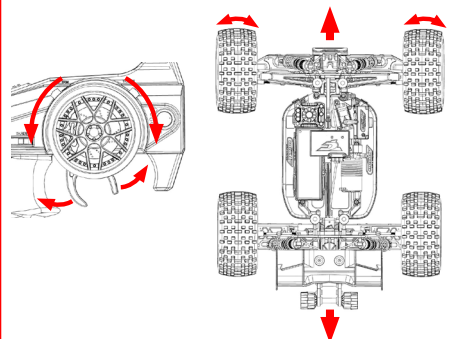

CHECK THE RADIO SYSTEM RANGE

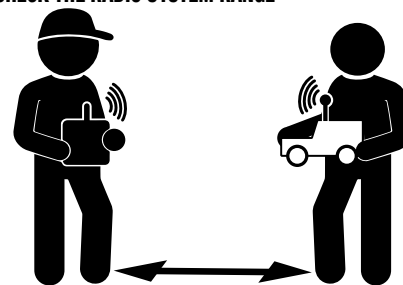

Move away from the max. distance you will drive the vehicle.
Check that the vehicle responds properly to the controls.
If not, reduce the distance or change the driving location.

DRIVE SLOWLY TO BEGIN

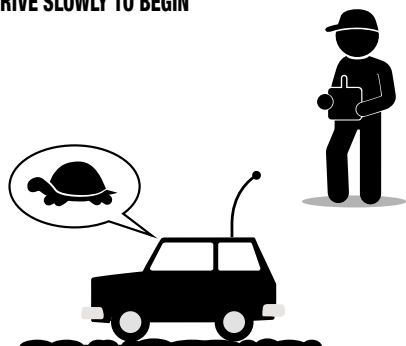

WHEN FINISHING

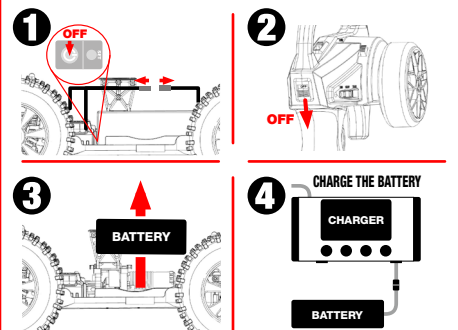

CLEAN AND MAINTAIN YOUR VEHICLE



FRONT TOE

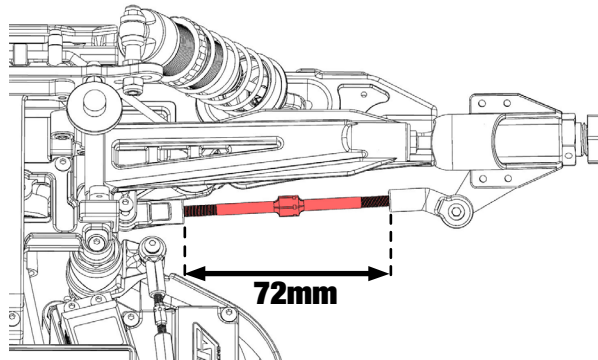
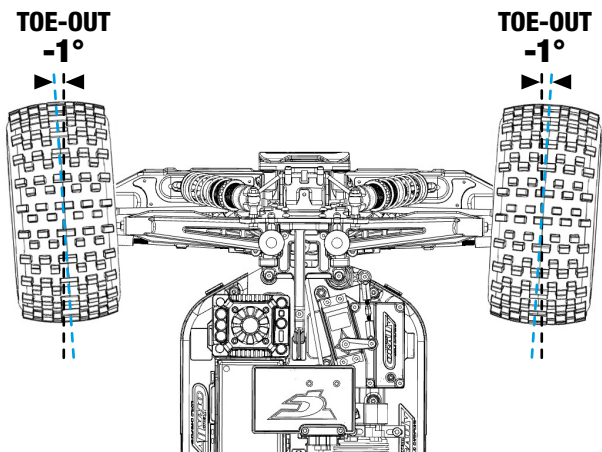

Adjust the angle by screwing the TURNBUCKLE.

FRONT CAMBER

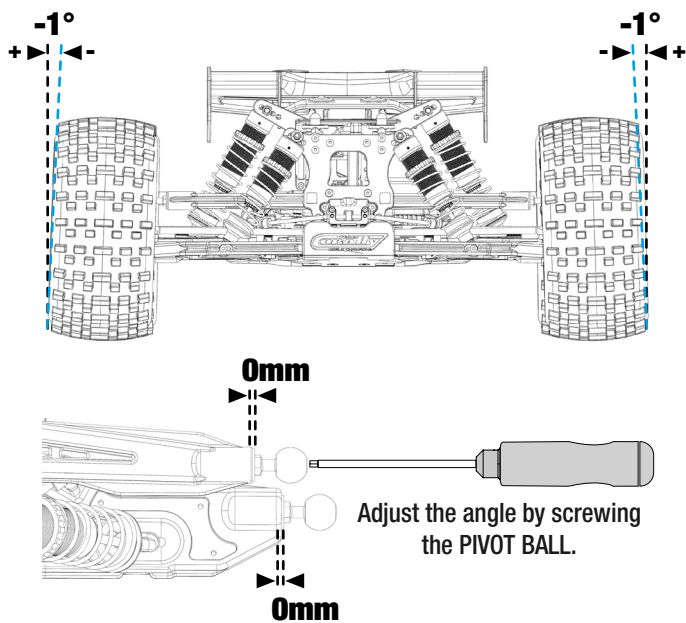

REAR CAMBER

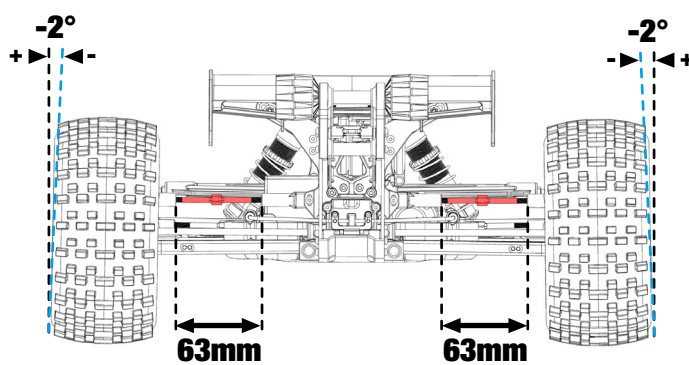

Adjust the angle by screwing the TURNBUCKLE.

FRONT CASTER

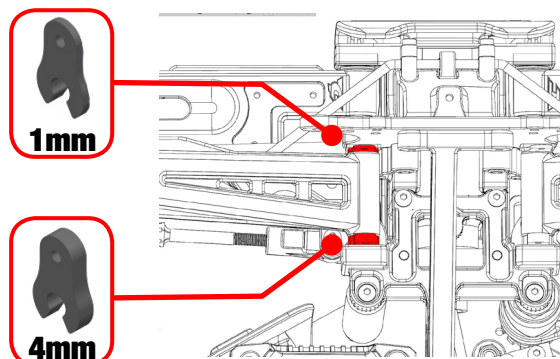
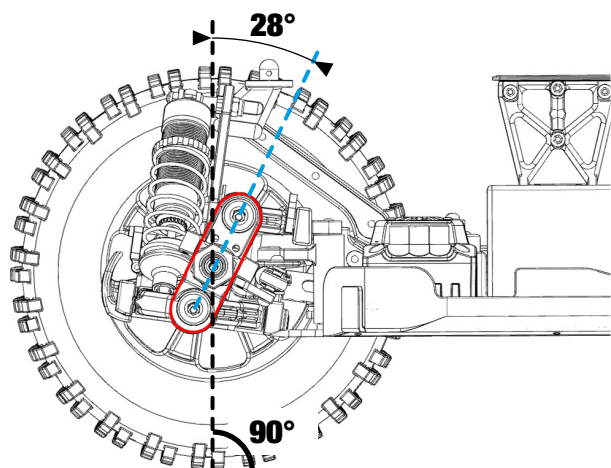

To change the Caster Angle, move the Upper Suspension Arm forward or backward using the different CASTER CLIPS sizes.

SUSPENSION TRAVEL

It is important to properly adjust the travel of the suspension arm to prevent the shock absorber from reaching the end of its travel and damaging it.

- Place the chassis on a block in order to release the suspension to the maximum.
- Measure the distance between the 2 fixing points of the shock absorber.
- If necessary adjust the FR & RE suspension travel by screwing the set screw on the FR & RE lower suspension arm.

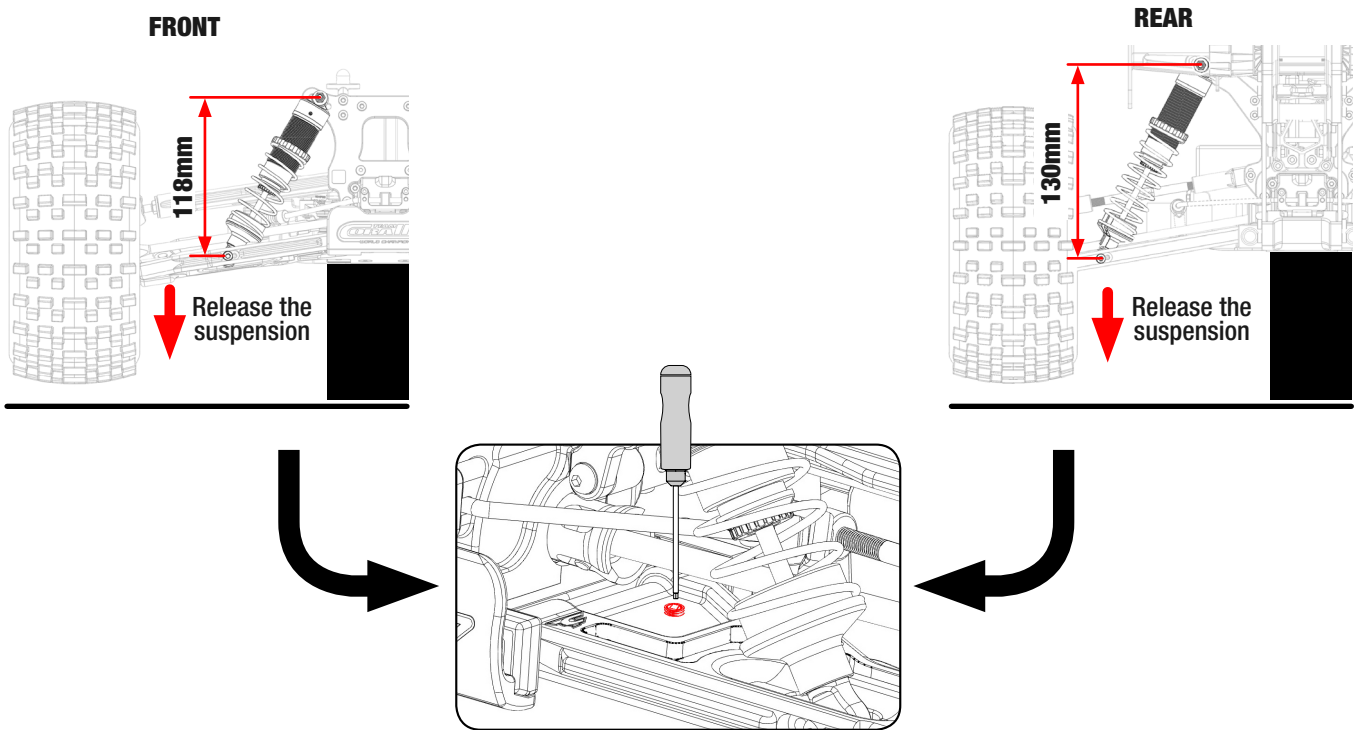

RIDE HEIGHT

To achieve the correct ground clearance setting, follow the instructions below.

- Lift the car by $\pm 30\text{cm}$ and drop the car on the floor.
- The front and rear suspension arms should be \pm parallel to the ground. (Neutral setup)
- Adjust the tension of the shock absorber spring according to the type of terrain.

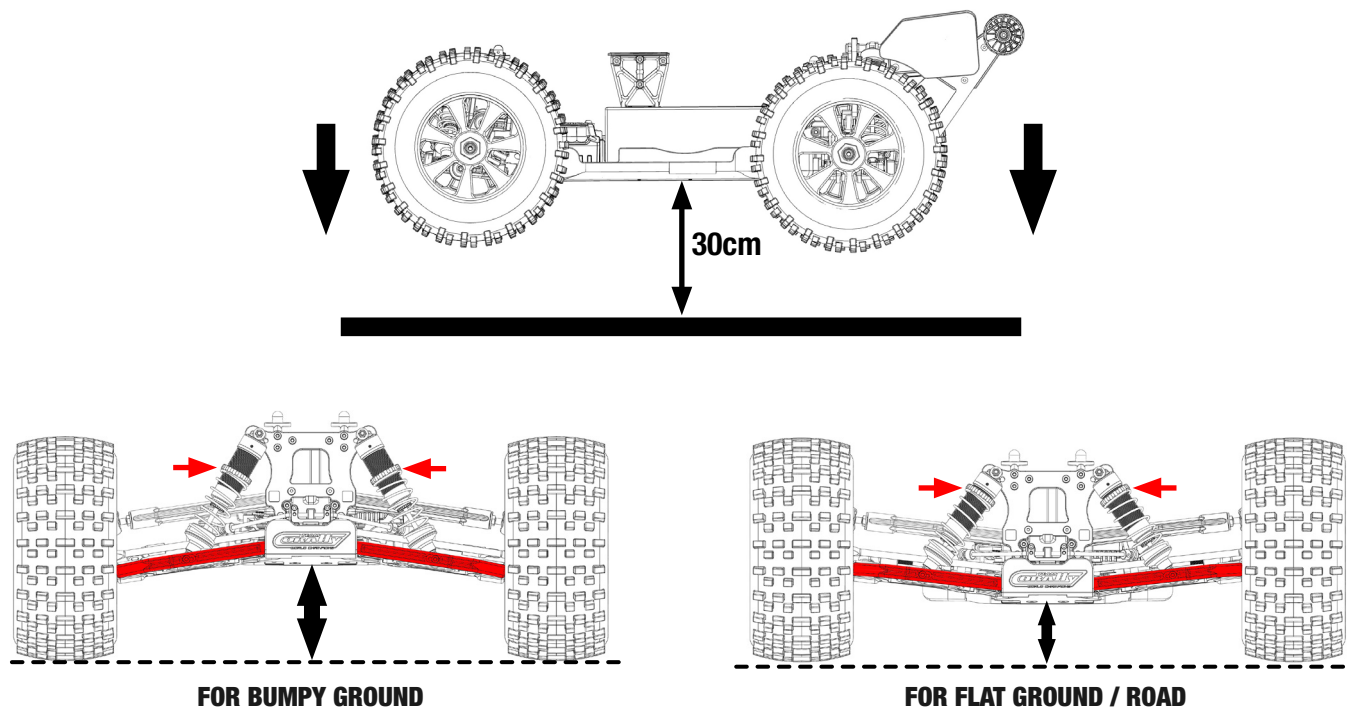

SHOCK ABSORBER MAINTENANCE

It may be necessary to replace the silicone oil in the shock absorbers every 40 runs. It depends on how you drive and the type of terrain you drive on.

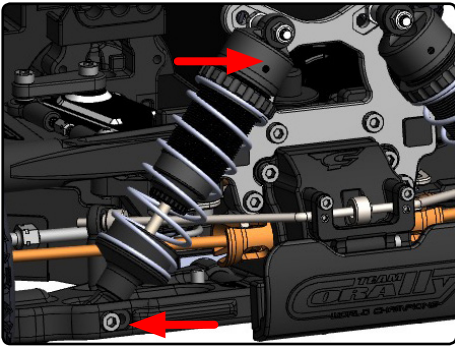

Remove the shock absorbers from the car. (4x)

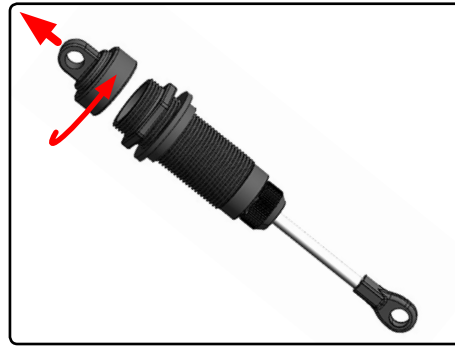

Remove the shock cap.

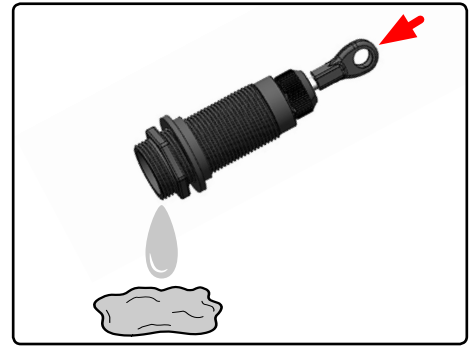

Drain the oil from the shock absorber.

FILL THE SHOCK ABSORBERS WITH NEW SILICONE OIL

ALWAYS USE SILICONE OIL, NEVER USE ANY OTHER TYPES OF OIL.

FILL

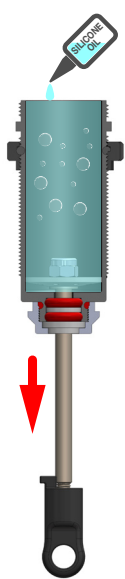

- Pull the Shock shaft down.
- Fill the shock body with silicone oil.
- **Front : 450cps**
Rear : 400cps

MOVE UP

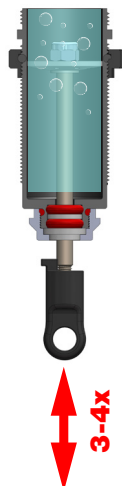

- Move the piston up&down (3-4x) to release the air bubbles in the silicone oil.

WAIT

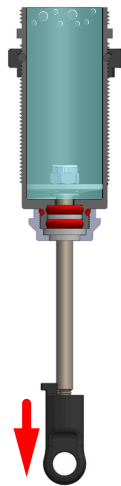

- Pull the Shock shaft down.
- Install the shock absorber vertically and let it sit for a few minutes until the bubbles rise to the surface.

TIGHTEN 50%

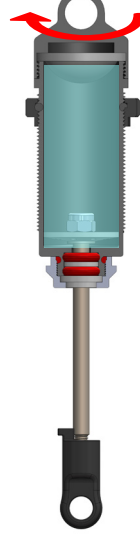

- Install the silicone membrane in the shock cap.
- Tighten slightly the shock cap on the shock body.
- A little oil will flow out of the shock absorber.

MOVE UP

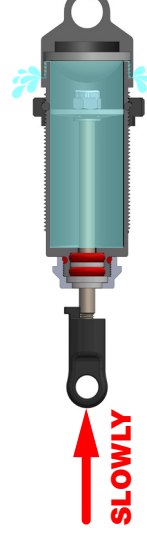

- Gently move the piston in upper position.
- The excess will flow out of the shock absorber.

TIGHTEN FULLY

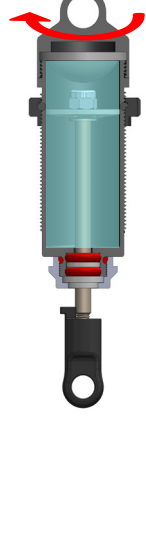

- Allow the piston in the upper position.
- Tighten the cap fully but not too much otherwise the membrane will be deformed.

	FRONT		REAR		SHOCK PISTON
	SILICONE OIL	SPRING TENSION	SILICONE OIL	SPRING TENSION	
TRACK USE	450CPS	4mm	400CPS	0mm	6 Holes Ø1.3mm
OFF-ROAD	600CPS	4mm	500CPS	0mm	6 Holes Ø1.3mm
BASHING	650CPS	4mm	550CPS	0mm	6 Holes Ø1.3mm

www.corally.com/Chemicals/Silicone-Oils/

SPRING TENSION

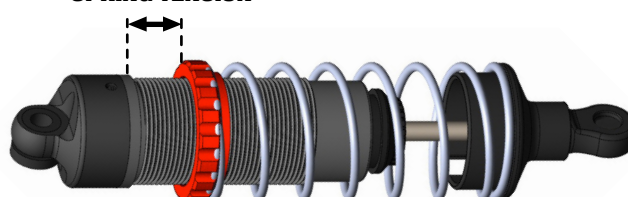

SHOCK ABSORBER - EXPLODED VIEW

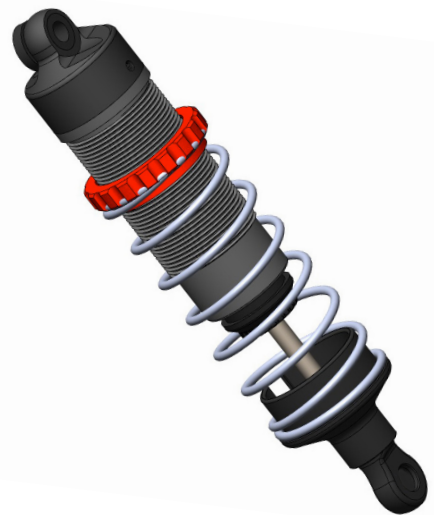

Do not overtighten the Shock Cap to prevent deformation of the silicone Shock Bladder.

C-00180-080 Shock Piston

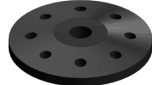

Set content

- Shock Piston - 4x1.6
- Shock Piston - 4x1.8
- Shock Piston - 5x1.4
- Shock Piston - 5x1.5
- Shock Piston - 5x1.6
- Shock Piston - 6x1.4
- Shock Piston - 6x1.3
- Shock Piston - 8x1.2
- Shock Piston - 8x1.3

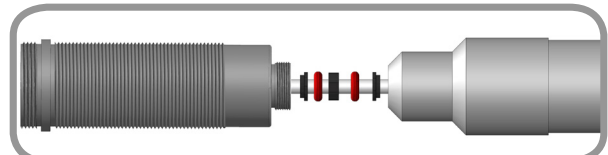
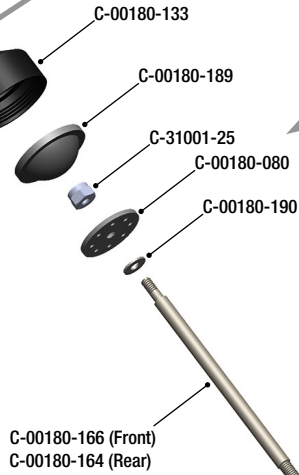

Place all small parts on a screwdriver (Ø3mm) and push them into the shock body. All parts will be properly aligned.

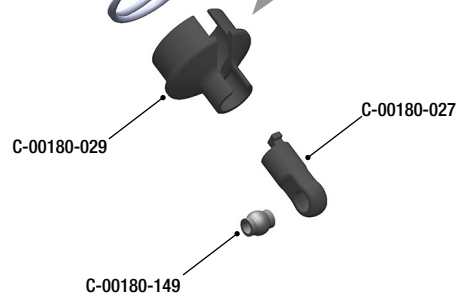
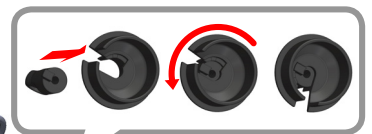
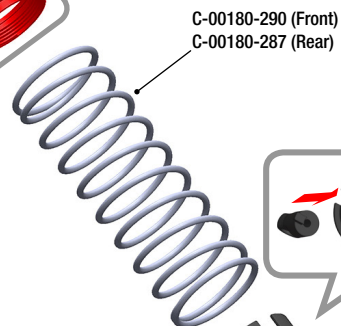
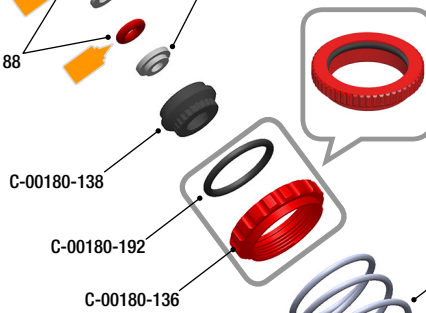
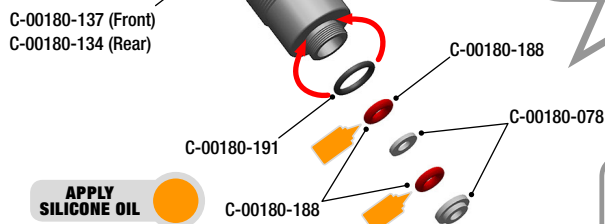

DIFFERENTIAL MAINTENANCE

It may be necessary to replace the silicone oil every 50 runs.
It depends on how you drive and the type of terrain you drive on.

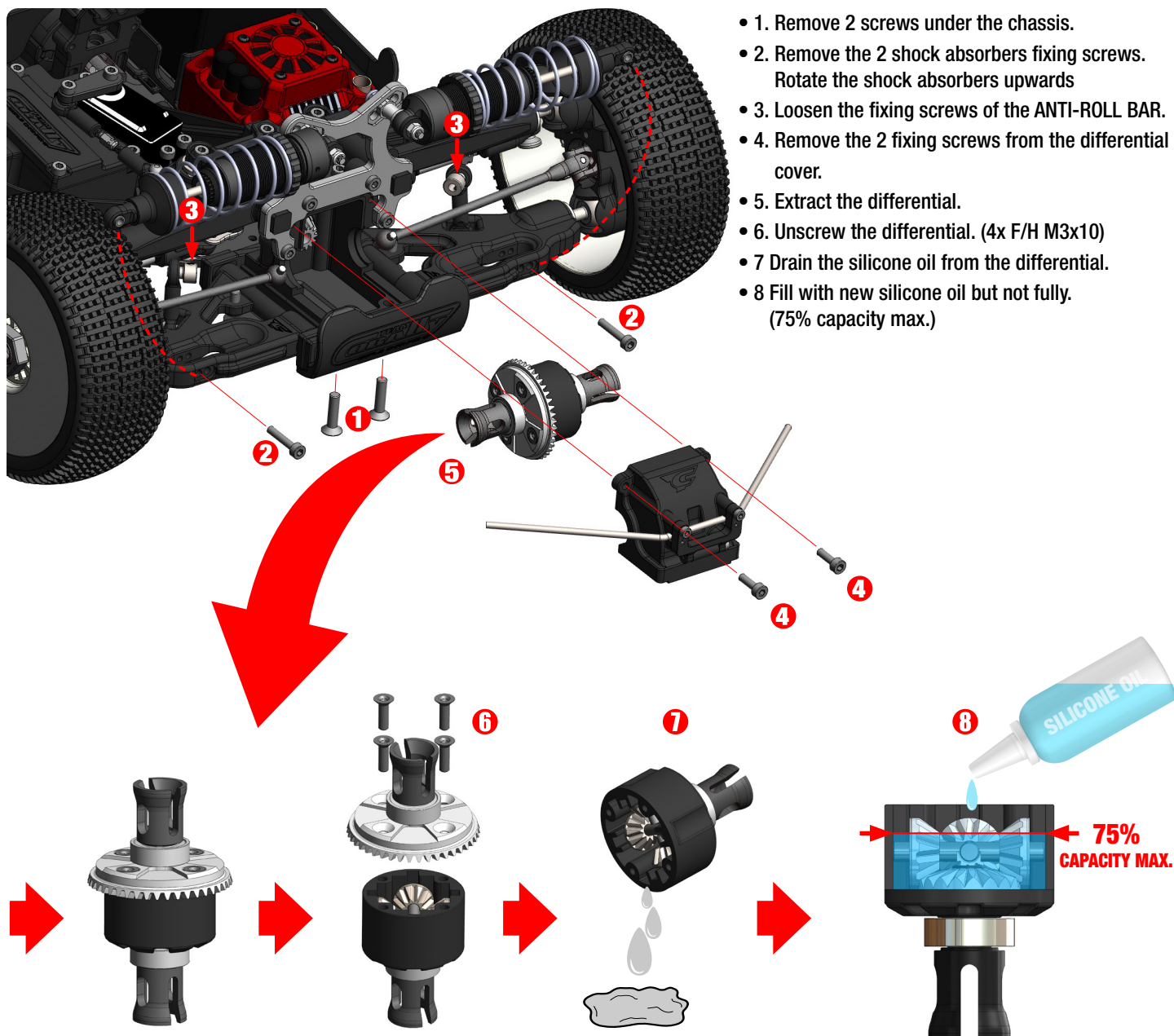

- 1. Remove 2 screws under the chassis.
- 2. Remove the 2 shock absorbers fixing screws. Rotate the shock absorbers upwards
- 3. Loosen the fixing screws of the ANTI-ROLL BAR.
- 4. Remove the 2 fixing screws from the differential cover.
- 5. Extract the differential.
- 6. Unscrew the differential. (4x F/H M3x10)
- 7 Drain the silicone oil from the differential.
- 8 Fill with new silicone oil but not fully. (75% capacity max.)

Perform the same maintenance operations for the centre and rear differentials.



Use the correct grade of silicone oil according to the operation.
Use only Silicone Oil, never use any other types of oil.

	FRONT DIFF	CENTRE DIFF	REAR DIFF
TRACK USE	7500CPS	15.000CPS	5000CPS
OFF-ROAD	10.000CPS	30.000CPS	7500CPS
BASHING	20.000CPS	50>100.000CPS	10.000CPS

www.corally.com/Chemicals/Silicone-Oils/

FRONT & REAR DIFFERENTIAL - EXPLODED VIEW

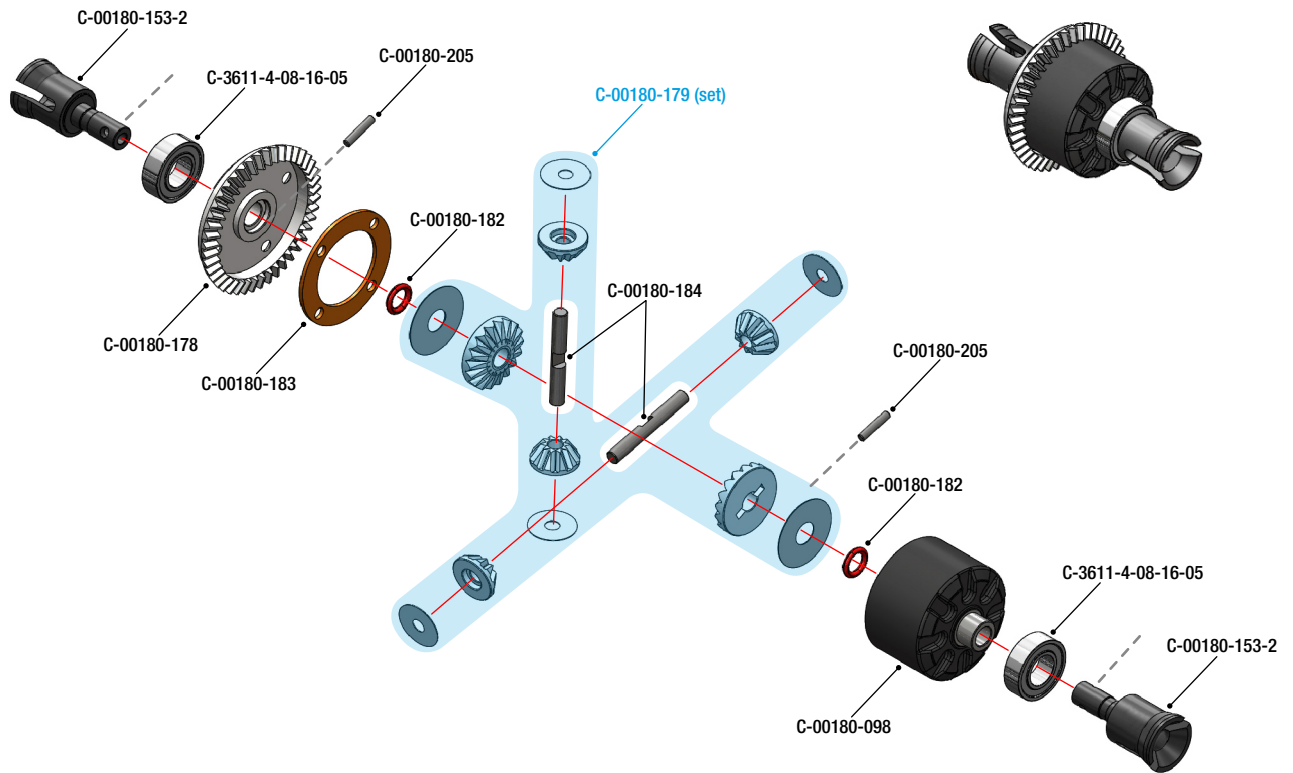

CENTRE DIFFERENTIAL - EXPLODED VIEW

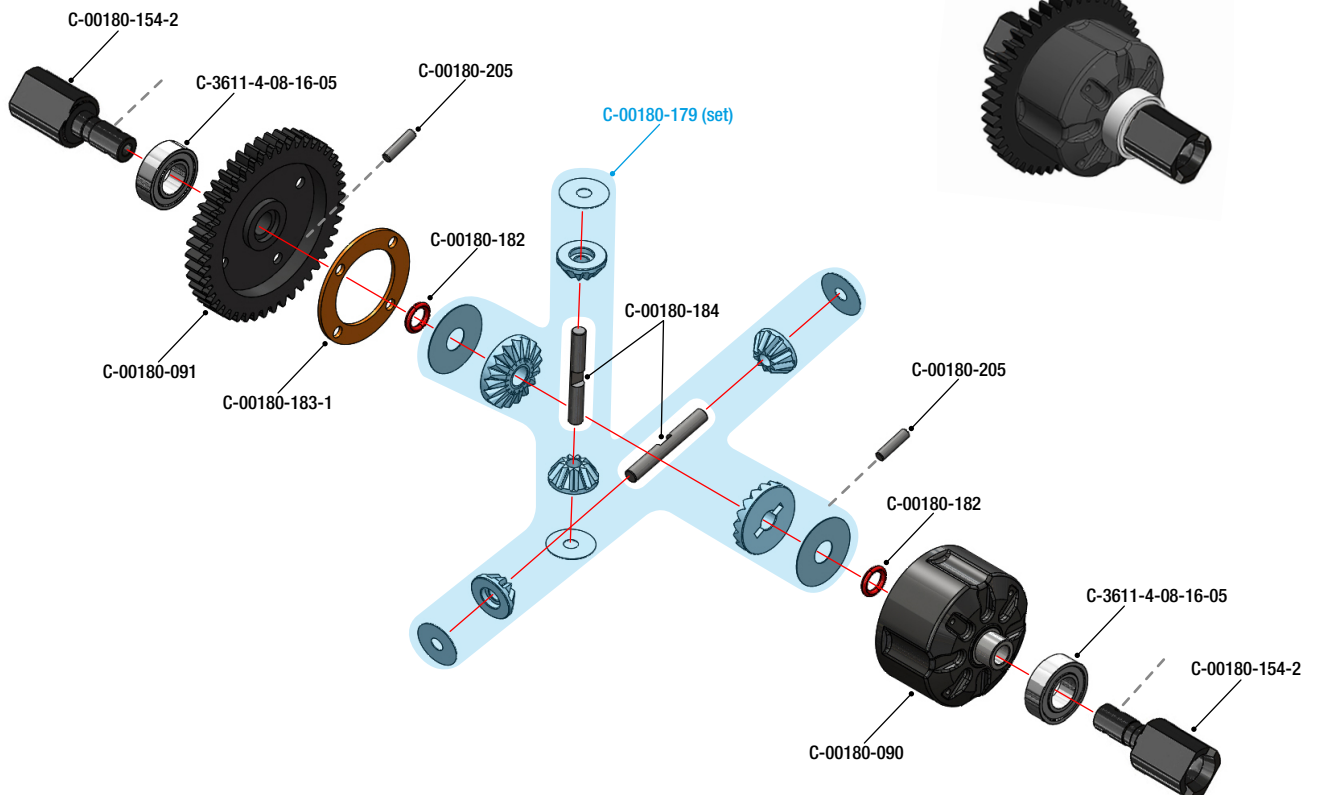

GEAR RATIO

MOTOR PINION MOD1.0

High-performance 13T tooth pinion gear, manufactured from special steel for toughness and durability with precise tolerances and assures unparalleled concentricity. Created on a special gear machine, all pinions feature ultra-precise tooth shaping and ultra-true running for vibration-free operation. Each pinion is marked with the tooth number for easy and quick identification.

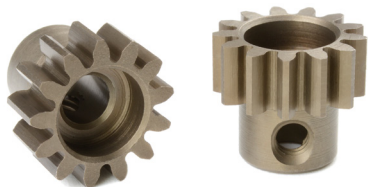

- Special hardened steel
- CNC cut teeth for perfect teeth shape and concentricity
- Module MOD1
- fits all cars with MOD1 gears (1/8 Scale)
- for 5.0mm motor shafts

www.corally.com/Pinions-Gears/Pinions-MOD1/

Motor Pinion	11T C-72711	12T C-72712	13T C-72713	14T C-72714	15T C-72715	16T C-72716	17T C-72717	18T C-72718	19T C-72719	20T C-72720	21T C-72721	22T C-72722	23T C-72723
Spur Gear	46T	46T	46T	46T	46T	46T	46T	46T	46T	46T	46T	46T	46T
3,08	12,87	11,79	10,89	10,11	9,44	8,85	8,33	7,86	7,45	7,08	6,74	6,43	6,15
	Optional	Optional	Standard Fitted	Not Suitable	Not Suitable	Not Suitable	Not Suitable	Not Suitable	Not Suitable	Not Suitable	Not Suitable	Not Suitable	Not Suitable



GEAR MESH ADJUSTMENT

If the gear mesh is not correct, you wear out the spur gear prematurely, the transmission will make noise, give unnecessary load on the motor (higher consumption, heating of the transmission).

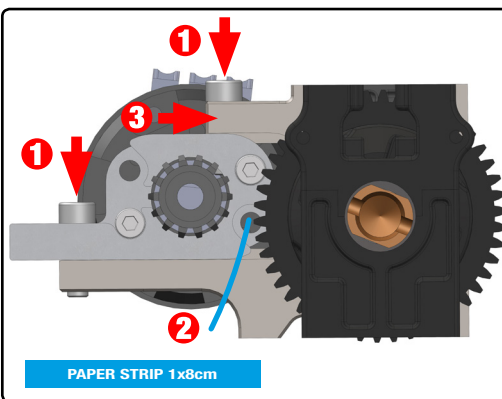
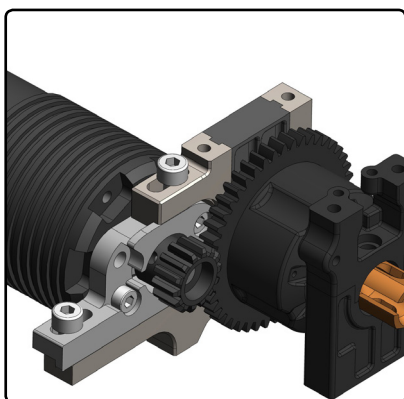

1. Loosen the screws.
2. Insert the paper strip.
3. Push the motor against the spur gear.

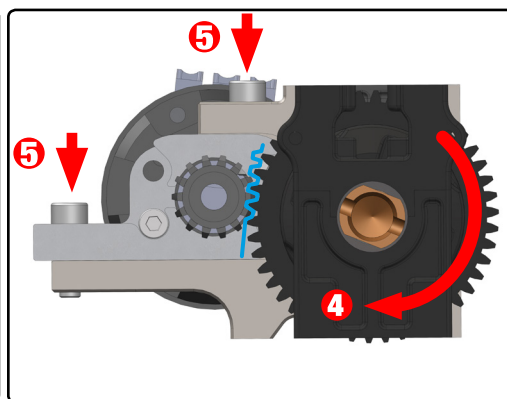

4. Turn the spur gear to run the paper through the teeth.
Stop when the paper is in the middle.
Make sure that the motor pinion is against the spur gear.
5. Tighten the fixing screws.

FRONT DRIVE TRAIN - EXPLODED VIEW

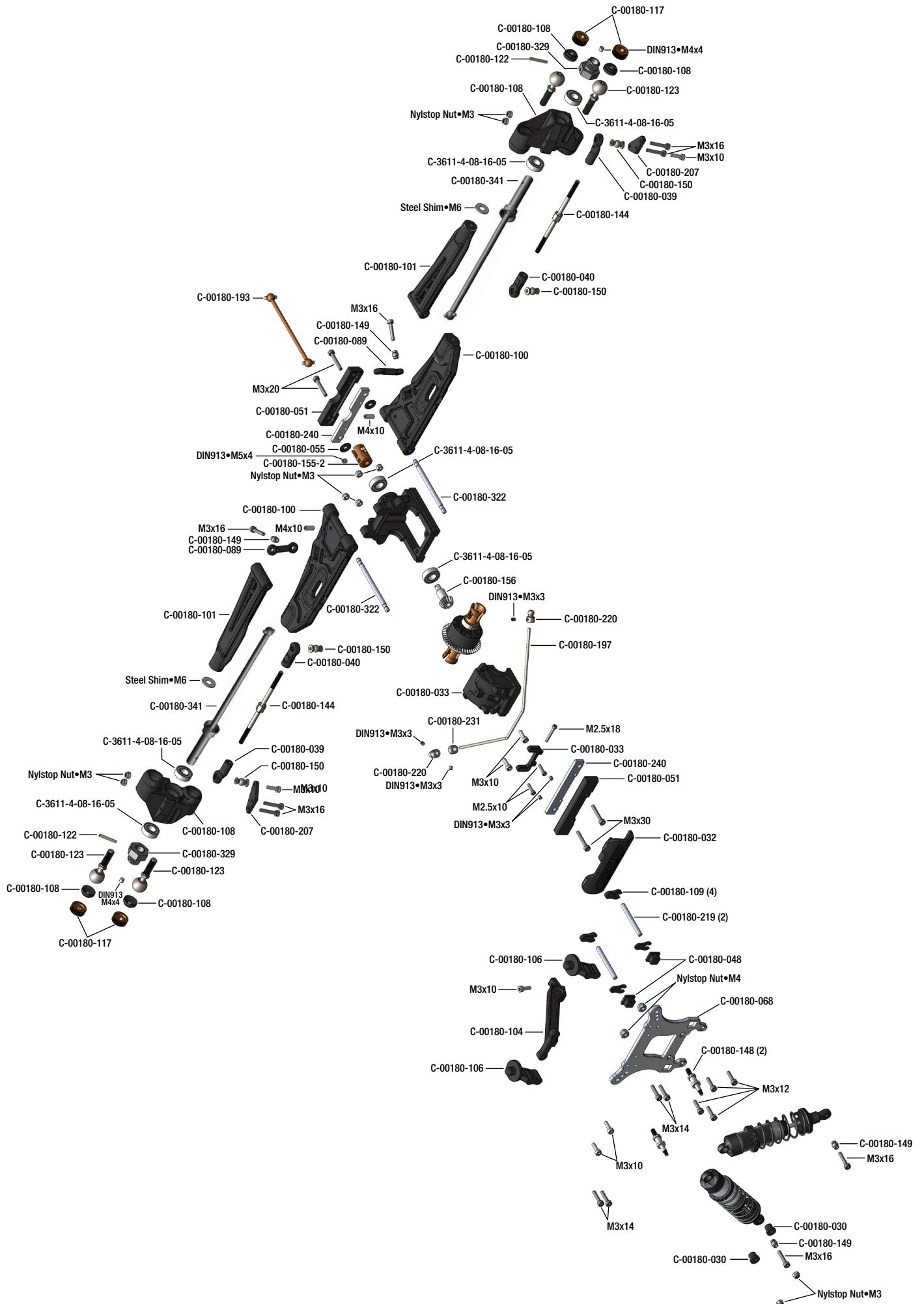



SEE SPARE PARTS AT



www.corally.com



C-00180-004
Battery - ESC Tray - Composite
- 1 pc



C-00180-004-1
Battery Strap - Hook & Loop
- 2 pcs



C-00180-005
Wing Mount - Adjustable -
Composite - 1 Set



C-00180-013
Servo Mount - Receiver Box -
Composite - 1 Set



C-00180-015
Centre Diff Plate - Spur Gear
Cover - Composite - 1 pc



C-00180-016
Chassis Brace - Rear - Com-
posite - 1 pc

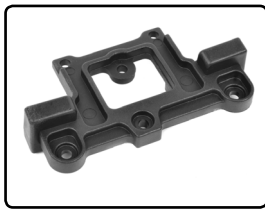

C-00180-017
Arm Holder - Steering Deck -
Composite - 1 pc



C-00180-018
Centre Diff Bulkhead - Compos-
ite - 1 Set



C-00180-020
Gearbox Brace Mount A - Rear -
Composite - 1 pc



C-00180-021
Gearbox Brace Mount Stiffener
- Composite - 1 pc



C-00180-023
Motor Mount Centre Diff Insert -
Composite - 1 pc



C-00180-027
Body Post - Composite - 2 pcs

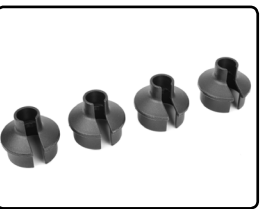

C-00180-029
Shock Spring Cup - Composite
- 4 pcs



C-00180-030
Shock Bushing - Composite -
4 pcs

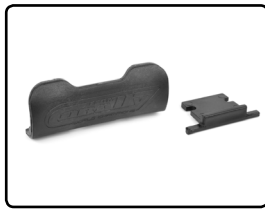

C-00180-032
Bumper - Front - Rear - Com-
posite - 1 set

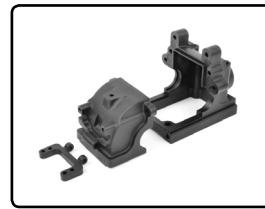

C-00180-033
Gearbox Case Set - Composite
- 1 Set



C-00180-036
Steering Bellcrank - Parts A-B-C
- Composite - 1 set



C-00180-039
Steering Ball Cups - Composite
- 1 set



C-00180-041
Rear Camber Ball Cups - Outer
- Inner - 1 set



C-00180-044
Ball Joint 6mm - Composite -
2 pcs

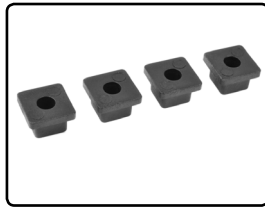

C-00180-048
Bushings Set - 0 Deg -
Composite - 1 Set

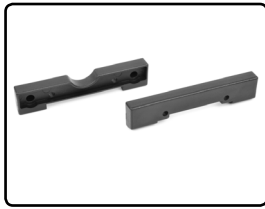

C-00180-051
Suspension Arm Mount - Front -
Composite - 1 Set

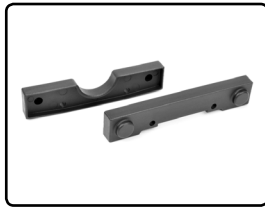

C-00180-052
Suspension Arm Mount - Rear -
Composite - 1 Set

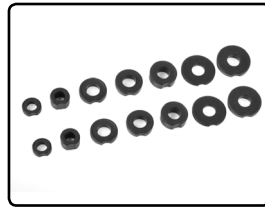

C-00180-055
Suspension Arm Shim - Com-
posite - 1 Set



C-00180-372
Servo Arm - Steering - Alu -
1 pc

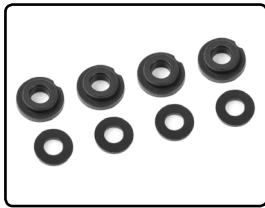

C-00180-078
Shock Body Insert - Washer -
Composite - 1 set

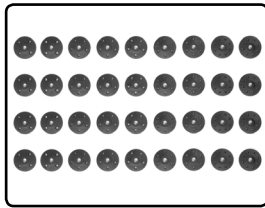

C-00180-080
Shock Piston - Composite - 9
versions - 4 pcs/type



C-00180-089
Anti-Roll Bar Ball Cups - Com-
posite - 4 pcs

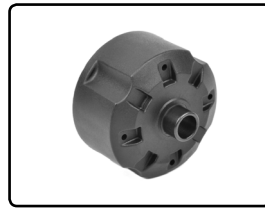

C-00180-090
Diff Case - Centre - Composite
- 1 pc

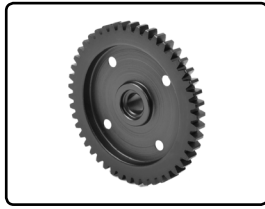

C-00180-091
Spur Gear 46T - Steel - 1 pc



C-00180-098
Diff Case - FR-RE - Composite
- 1 pc

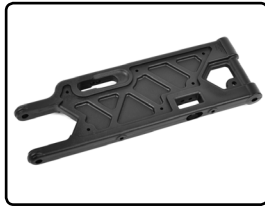

C-00180-099
Suspension Arm Long - Lower -
Rear - Composite - 1 pc



C-00180-100
Suspension Arm Long - Lower -
Front - Composite - 1 pc



C-00180-101
Suspension Arm Long - Upper -
Front - Composite - 1 pc

SPARE PARTS



C-00180-102
Chassis Brace - Front - Composite - 1 pc



C-00180-104
Shock Tower Brace - Front - Composite - 1 pc

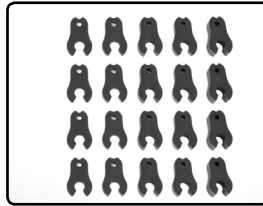

C-00180-109
Caster Clips Set - 1 to 4.5mm - 1 Set



C-00180-106
Body Post - Front - Composite - 2 pcs

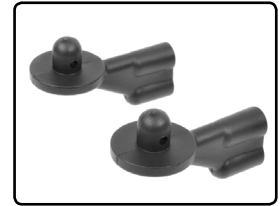

C-00180-107
Body Post - Rear - Composite - 2 pcs



C-00180-108
Steering Block Wide - Pivot Ball Cup (2) - Front - Composite - 1 set



C-00180-114
Rear Upright - MT - Composite - 1 pc



C-00180-117
Pivot Ball Adjusting Nut - Aluminium - 4 pcs

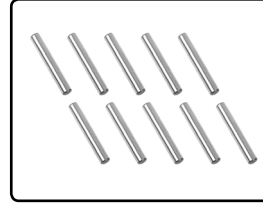

C-00180-122
Pin 2.5x17mm - Steel - 10 pcs



C-00180-123
Pivot Ball - Steel - 4 pcs



C-00180-127
Hinge Pin - Outer - Steel - 2 pcs



C-00180-129
Turnbuckle - M3 - 35mm - Steel - 2 pcs



C-00180-133
Shock Cap - Aluminium - Hard Anodised - 2 pcs



C-00180-134
Shock Body - Rear - Aluminium - Hard Anodised - 1 pc



C-00180-136
Shock Collar - Aluminium - Hard Anodised - 2 pcs



C-00180-137
Shock Body - Front - Aluminium - Hard Anodised - 1 pc



C-00180-143
Turnbuckle - M5 - 92mm - Steel - 2 pcs



C-00180-144
Turnbuckle - M4 - 92mm - Steel - 2 pcs



C-00180-145
Servo Saver Shaft w/ Nut - Aluminium - 1 pc



C-00180-147
Servo Saver Post - Steel - 2 pcs



C-00180-148
Shock Screw - Steel - 4 pcs



C-00180-149
Ball - 5.8mm - Steel - 4 pcs



C-00180-150
Ball Shouldered - 6.8mm - Steel - 4 pcs



C-00180-153-2
Diff. Outdrive Cup - SP2 EXH Steel - 2 pcs



C-00180-154-2
Center Diff. Outdrive Cup - SP2 EXH Steel - 2 pcs



C-00180-155-2
Pinion Outdrive Cup - SP2 EXH Steel - 2 pcs



C-00180-156
Bevel Pinion 13T - Steel - 1 pc



C-00180-164
Shock Shaft - 66mm - Rear - Steel - 2 pcs



C-00180-166
Shock Shaft - 61mm - Front - Steel - 2 pcs



C-00180-168
Shock Tower - 4mm - Aluminium - Front - 1 pc



C-00180-169
Shock Tower - 5mm - Aluminium - Rear - 1 pc



C-00180-170
Ball - 6.8mm - Steel - 2 pcs



C-00180-171
Threaded Ball - 6mm - Steel - 2 pcs



C-00180-175
Steering Rack - Aluminium 7075 - 1 pc



C-00180-176
Motor Bulkhead - Aluminium - 1 pc

SPARE PARTS



C-00180-177
Motor Mount - Aluminium - 1 pc



C-00180-178
Diff. Bevel Gear 43T - Steel - 1 pc

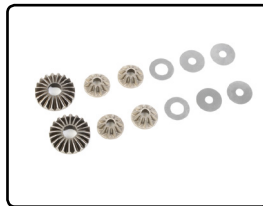

C-00180-179
Planetary Diff. Gears - Steel - 1 Set

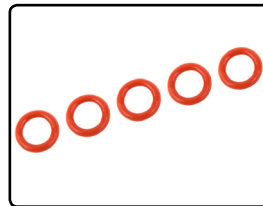

C-00180-182
O-Ring - Silicone - 5x8mm - 5 pcs

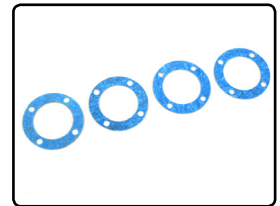

C-00180-183
Diff. Gasket - 4 pcs



C-00180-184
Gear Diff. Pin - Steel - 2 pcs



C-00180-188
O-Ring - Silicone - 4x8mm - 5 pcs

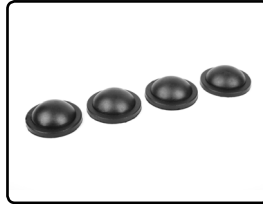

C-00180-189
Shock Bladders - Silicone - 4 pcs

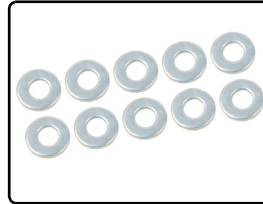

C-00180-190
Shock Washer - 2.5x6x0.5mm - Steel - 10 pcs

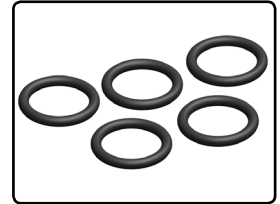

C-00180-191
O-Ring - Silicone - 9x12mm - 5 pcs

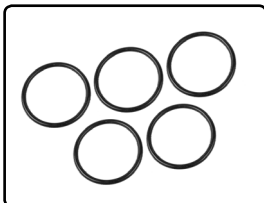

C-00180-192
O-Ring - Silicone - 16.2x19.8mm - 5 pcs

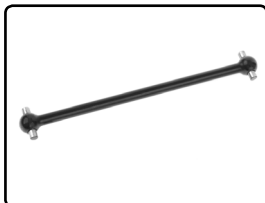

C-00180-193
Drive Shaft - Centre - Front - Steel - 1 pc

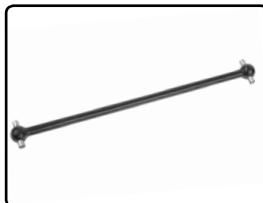

C-00180-194
Drive Shaft - Centre - Rear - Steel - 1 pc



C-00180-197
Anti-Roll Bar - 2.4mm - Front - 1 pc

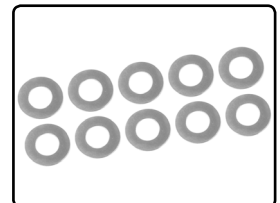

C-00180-204
Shim Rings - 6x18x0.2mm - Steel - 10 pcs



C-00180-205
Diff. Outdrive Pin - 2x11,8mm - Steel - 4 pcs



C-00180-206
Steering Rack Bushing - Steel - 2 pcs



C-00180-207
Steering Block Arms - Aluminium - 2 pcs

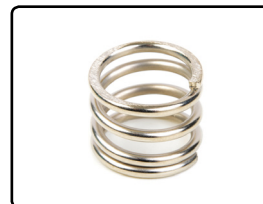

C-00180-216
Servo Saver Spring - 1 pc

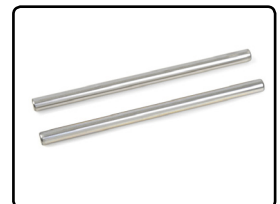

C-00180-219
Suspension Arm Pivot Pin - Upper - Front - Steel - 2 pcs



C-00180-220
Ball End 5.8mm - for Anti Roll Bar - Steel - 4 pcs



C-00180-226-B
Wing - Composite - 1 pc

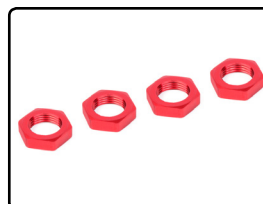

C-00180-230
Wheel Nut - Aluminium - 4 pcs



C-00180-231
Collar - for Anti-roll Bar - Aluminium - 1 pc

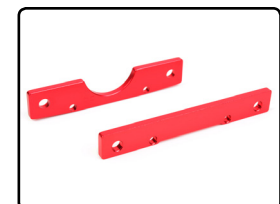

C-00180-238
Suspension Arm Mount - Rear - Aluminium - 1 set

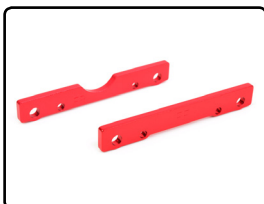

C-00180-240
Suspension Arm Mount - Front - Aluminium - 1 Set



C-00180-242
Side Guards - Left-Right - Composite - 1 Set



C-00180-246
Anti-Roll Bar - 2.6mm - Rear - 1 pc

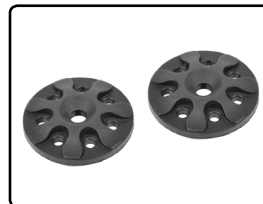

C-00180-251
Wing Washer - Composite - 2 pcs

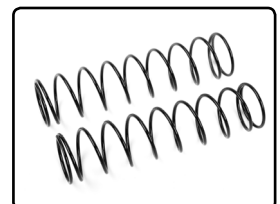

C-00180-287
Shock Spring - Medium - Rear - 2 pcs

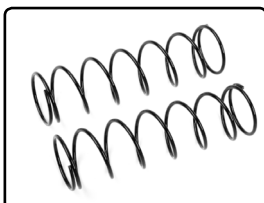

C-00180-290
Shock Spring - Medium - Front - 2 pcs



C-00180-293
Ball 6.8mm - Steel - 4 pcs



C-00180-295
Wheelie Bar Wheel Axle - Steel - 1 pc



C-00180-296
Wheelie Bar Mount - Left-Right - Composite - 1 set



C-00180-298
Wheelie Bar Wheels - Composite - 2 pcs

SPARE PARTS



C-00180-300
Wheelie Bar Spacer - Aluminium
- 1 pc



C-00180-301
Centre Roll Cage Mount - Composite
- 1 Set

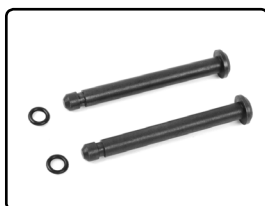

C-00180-305
Centre Roll Cage Pin - Steel
- 2 pcs



C-00180-307
Wheelie Bar Plate - Aluminium
- 1 pc



C-00180-316
Shock Cap - Lower - Aluminium
- 2 pcs

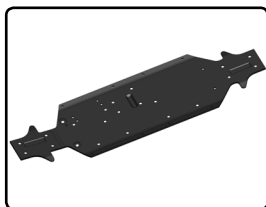

C-00180-321
Chassis - Buggy XP RTR - Aluminium
- 1 pc

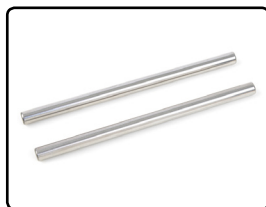

C-00180-322
Suspension Arm Pivot Pin - Low Inner - Fr/Re - Steel
- 2 pcs



C-00180-329
Wheel Hex Adapter - Wide RTR - Aluminium
- 2 pcs



C-00180-341
CVD Drive Shaft - Long - Front - Wide Blocks
- 1 pc



C-00180-367
Dogbones - Long - Rear - Steel
- 2 pcs



C-00180-368-2
Drive Axle - Rear - Wide Hub - V2 - SP2 EXH Steel
- 2 pcs



C-00180-372
Servo Arm - Steering - Alu
- 1 pc



C-00180-378
Off-Road 1/8 MT Tires - Gripper - Glued on Black Rims
- 1 pair



C-00180-381
Polycarbonate Body - Dementor XP 6S - Painted - Cut
- 1 pc



C-00180-383
Roll Cage - Dementor - 1 Set

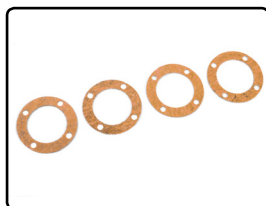

C-00180-183-1
Central Diff. Gasket - 4 pcs



C-52021
Digital Servo - CR-7220-MG - Low Voltage - Core Motor - Metal Gear
- 20 Kg Torque



C-54011
Speed Controller - TOROX 185 - Brushless
- 2-6S



C-54055
Electric Motor - Kuron 825 - 4-Pole - 2050 KV - Brushless - Sensorless



C-72713
M1.0 Pinion - Hardened Steel - 13 Teeth - Shaft Dia. 5mm

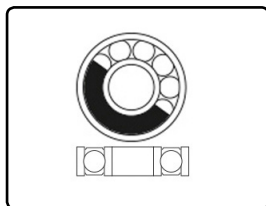

C-3611-3-05-10-04
Ball Bearing - Abec 3
5x10x4mm - 2 pcs

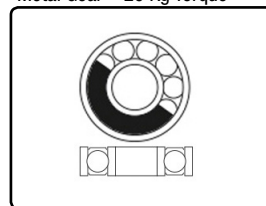

C-3611-4-06-10-03
Ball Bearing - Abec 3
6x10x3mm - 2 pcs

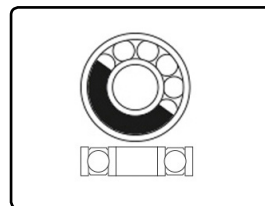

C-3611-4-08-16-05
Ball Bearing - Abec 3
8x16x5mm - 2 pcs

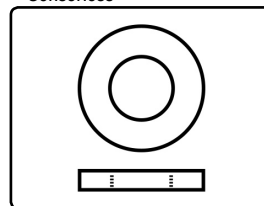

C-3201-40
Steel Shim - M4 - 10 pcs

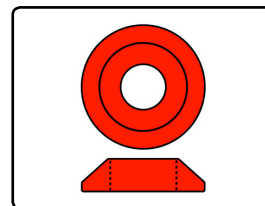

C-31205
Aluminium Washer - for M3 Flat Head Screws - Red - 10 pcs

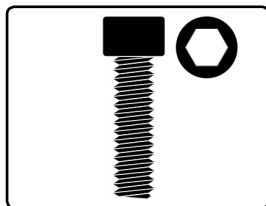

SOCKET HEAD SCREWS - 10 PCS

C-3001-25-10	M2.5x10
C-3001-25-20	M2.5x20
C-3001-30-06	M3x6
C-3001-30-08	M3x8
C-3001-30-10	M3x10
C-3001-30-12	M3x12
C-3001-30-14	M3x14
C-3001-30-16	M3x16
C-3001-30-20	M3x20
C-3001-30-25	M3x25
C-3001-30-30	M3x30
C-3001-40-08	M4x8



FLAT HEAD SCREWS - 10 PCS

C-3002-30-08	M3x8
C-3002-30-10	M3x10
C-3002-40-10	M4x10
C-3002-40-12	M4x12
C-3002-40-14	M4x14
C-3002-40-16	M4x16
C-3002-40-18	M4x18

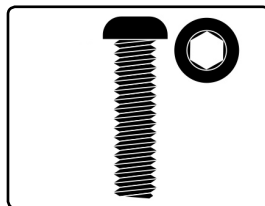

BUTTON HEAD SCREWS - 10 PCS

C-3003-30-06	M3x6
C-3003-30-10	M3x10
C-3003-30-12	M3x12
C-3003-30-16	M3x16
C-3003-40-12	M4x12

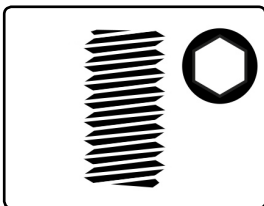

SET SCREWS - 10 PCS

C-3004-30-03	M3x3
C-3004-30-05	M3x5
C-3004-40-04	M4x4
C-3004-50-04	M5x4

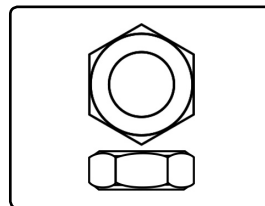

C-3104-40
Steel Nut - Low Profile - M4 - 10 pcs

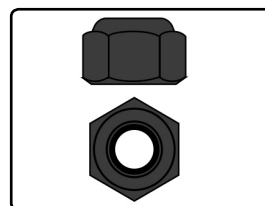

NYLSTOP NUT - 10 PCS

C-31001-25	M2.5
C-31001-30	M3
C-31001-40	M4

OPTION PARTS

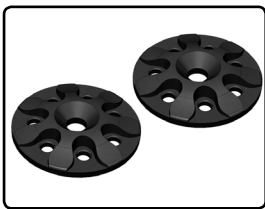

C-00180-157
Wing Washer - Lightened -
Aluminum - 2 pcs

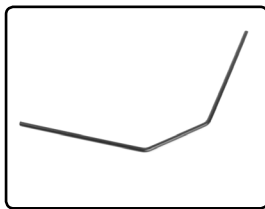

C-00180-195
Anti-Roll Bar - 2.6mm - Front
- 1 pc

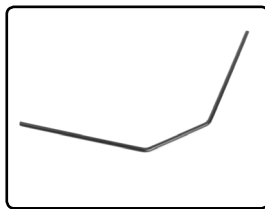

C-00180-196
Anti-Roll Bar - 2.5mm - Front
- 1 pc

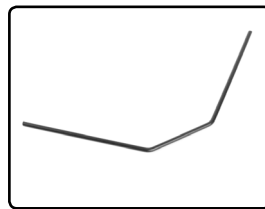

C-00180-198
Anti-Roll Bar - 2.2mm - Front
- 1 pc

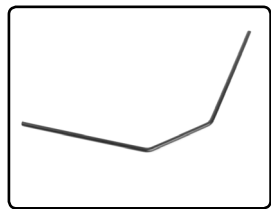

C-00180-199
Anti-Roll Bar - 2.0mm - Front
- 1 pc



C-00180-224
Fan Holder - Composite - 1 set

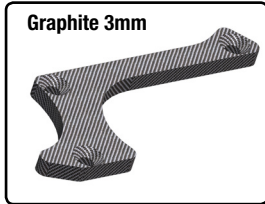

Graphite 3mm
C-00180-232
Susp. arm stiffener - A - Lower
Front - Right - Graphite 3mm - 1 pc

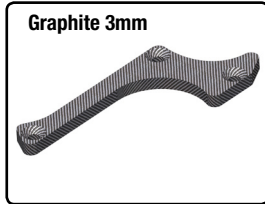

Graphite 3mm
C-00180-233
Susp. arm stiffener - A - Lower
Front - Left - Graphite 3mm - 1 pc

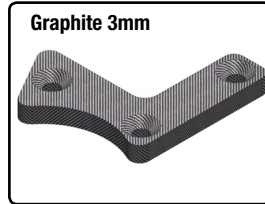

Graphite 3mm
C-00180-234
Susp. arm stiffener - B - Lower
Front - Right - Graphite 3mm - 1 pc

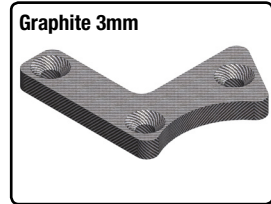

Graphite 3mm
C-00180-235
Susp. arm stiffener - B - Lower
Front - Left - Graphite 3mm - 1 pc

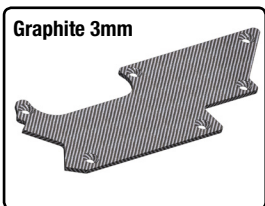

Graphite 3mm
C-00180-236
Suspension arm stiffener - Rear
- Right - Graphite 3mm - 1 pc

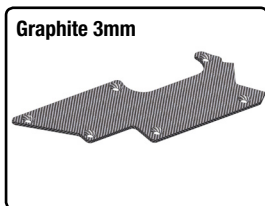

Graphite 3mm
C-00180-237
Suspension arm stiffener - Rear
- Left - Graphite 3mm - 1 pc

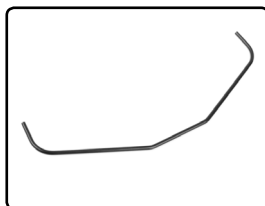

C-00180-247
Anti-Roll Bar - Rear - 2.8mm
- 1 pc

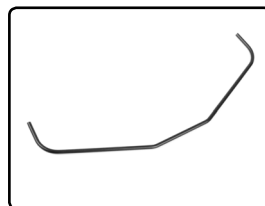

C-00180-248
Anti-Roll Bar - Rear - 3.0mm
- 1 pc

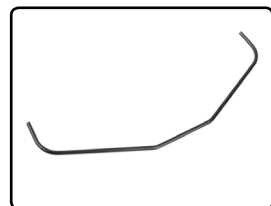

C-00180-249
Anti-Roll Bar - Rear - 2.4mm
- 1 pc

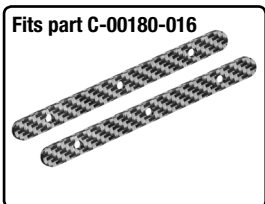

Fits part C-00180-016
C-00180-253
Chassis Brace Stiffener - Rear -
Graphite 2.5mm - 2 pcs



Fits part C-00180-104
C-00180-255
Chassis Brace Stiffener - Front
- Graphite 2.5mm - 2 pcs

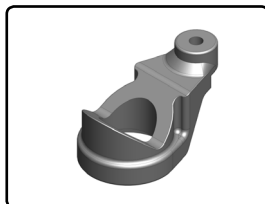

C-00180-266
Servo Saver Steering Arm -
Aluminium - 1 pc

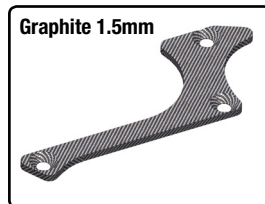

Graphite 1.5mm
C-00180-272
Susp. arm stiffener - A - Lower Front
- Right - Graphite 1.5mm - 1 pc

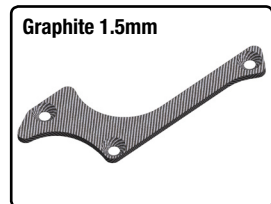

Graphite 1.5mm
C-00180-273
Suspension arm stiffener - A - Lower
Front - Left - Graphite 1.5mm - 1 pc

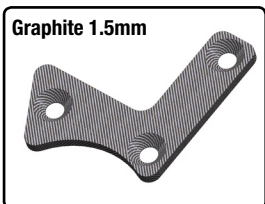

Graphite 1.5mm
C-00180-274
Susp. arm stiffener - B - Lower Front
- Right - Graphite 1.5mm - 1 pc

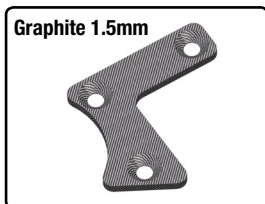

Graphite 1.5mm
C-00180-275
Susp. arm stiffener - B - Lower Front
- Left - Graphite 1.5mm - 1 pc

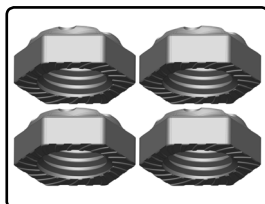

C-00180-284
Wheel Nut - Closed - Aluminium
- 4 pcs

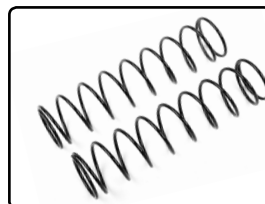

C-00180-286
Shock Spring - Soft - Rear
- 2 pcs

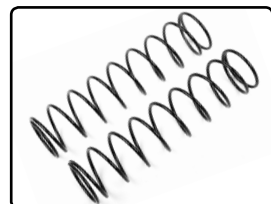

C-00180-288
Shock Spring - Hard - Rear
- 2 pcs

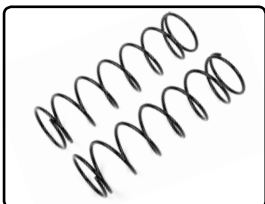

C-00180-289
Shock Spring - Soft - Front
- 2 pcs



C-00180-291
Shock Spring - Hard - Front
- 2 pcs



C-00180-308
Wheelie Bar Plate - Graphite
- 1 pc

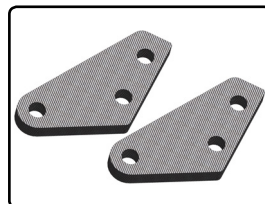

C-00180-315
Steering Block Arms - Graphite
2.5mm - 2 pcs

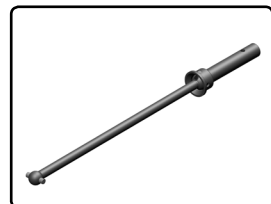

C-00180-346
CVD Drive Shaft - Long - Rear -
Wide Hub - 1 pc

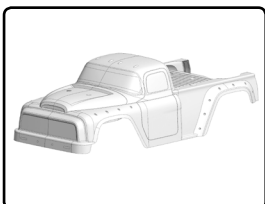

C-00180-382
Polycarbonate Body - Dementor
XP 6S - Clear - Cut - 1 pc



C-72714
M1.0 Pinion - Hardened Steel -
14 Teeth - Shaft Dia. 5mm

DECLARATION OF CONFORMITY
EU-Konformitätserklärung/ Déclaration de Conformité UE

(in accordance with ISO/IEC 17050-1) / (in Übereinstimmung mit ISO/IEC 17050-1) /
 (Conformément à la norme ISO/IEC 17050-1)

Description : **1/8 DEMENTOR MONSTER TRUCK 4WD - RTR**
 Item Number: **C-00165**

This declaration is issued under the sole responsibility of the manufacturer.
 Die alleinige Verantwortung für die Ausstellung dieser Erklärung trägt der Hersteller.
 La présente déclaration est établie sous la seule responsabilité du fabricant.

Product(s)/Produkt(e)/ Produit(s) : **1/8 DEMENTOR MONSTER TRUCK 4WD - RTR**

The object of declaration described above is in conformity with the relevant Union harmonization Legislation, specifically the requirements of the specifications listed below, following the provisions of the European RED Directive 2014/53/EU:
 Der Gegenstand dieser Erklärung ist konform mit den Harmonisierungsrechtsvorschriften der Europäischen Union, insbesondere mit den unten aufgeführten Bestimmungen, und folgt der europäischen RED Direktive 2014/53/EU:
 L'objet de la déclaration décrit ci-dessus est conforme à la législation pertinente en matière d'harmonisation de l'Union européenne, en particulier les exigences des spécifications énumérées ci-dessous, conformément aux dispositions des directives européennes RED 2014/53/EU:

EN 300 440 V2.1.1:2017	EN 301 489-3 V1.6.1:2013
EN 301 489-1 V2.1.1:2017	EN 60950-1:2006+A11:2009+A1:2010+A12:2011+A2:2013
EN 62479:2010	EN 55024:2010+A1:2015
EN 55032:2015	EN 61000-3-3:2013
EN 61000-3-2:2014	

JSP GROUP INTL • Geelseweg, 80 • 2250 Olen • Belgium

Signed for and on behalf of/ Unterzeichnet für und im Namen von/ Signé pour et au nom de :

Place/Ort/Lieu and Date/Datum/Data : **Olen, Belgium, 25 September 2019**

Name/Nom: **Stefan Engelen**
 Title/Titel/Titre : **Ceo**

Signature/Unterschrift :



FEDERAL COMMUNICATIONS COMMISSION

EQUIPMENT AUTHORIZATION is hereby issued to the named GRANTEE JSP GROUP INTL BVBA / CORALLY, and is VALID ONLY for the equipment identified hereon for use under the Commission's Rules and Regulations listed below.

FCC IDENTIFIER : **2ASZJ-VP010005**
 Name of Grantee : **JSP GROUP INTL BVBA / CORALLY**
 Equipment Class : **Part 15 Low Power Communication Device Transmitter**
 Notes : **VARIOPROP S2R**
 FCC Rules : **15C**
 Frequency Range (MHZ) : **2410.0 - 2480.0**



WWW.CORALLY.COM

Team Corally is a registered trademark licensed to
JSP Group Intl bvba • Geelseweg 80 • B-2250 OLEN • Belgium
Tel: +32 14 25 92 94 • info@corally.com